

## Fitting instructions

## FITTING INSTRUCTION

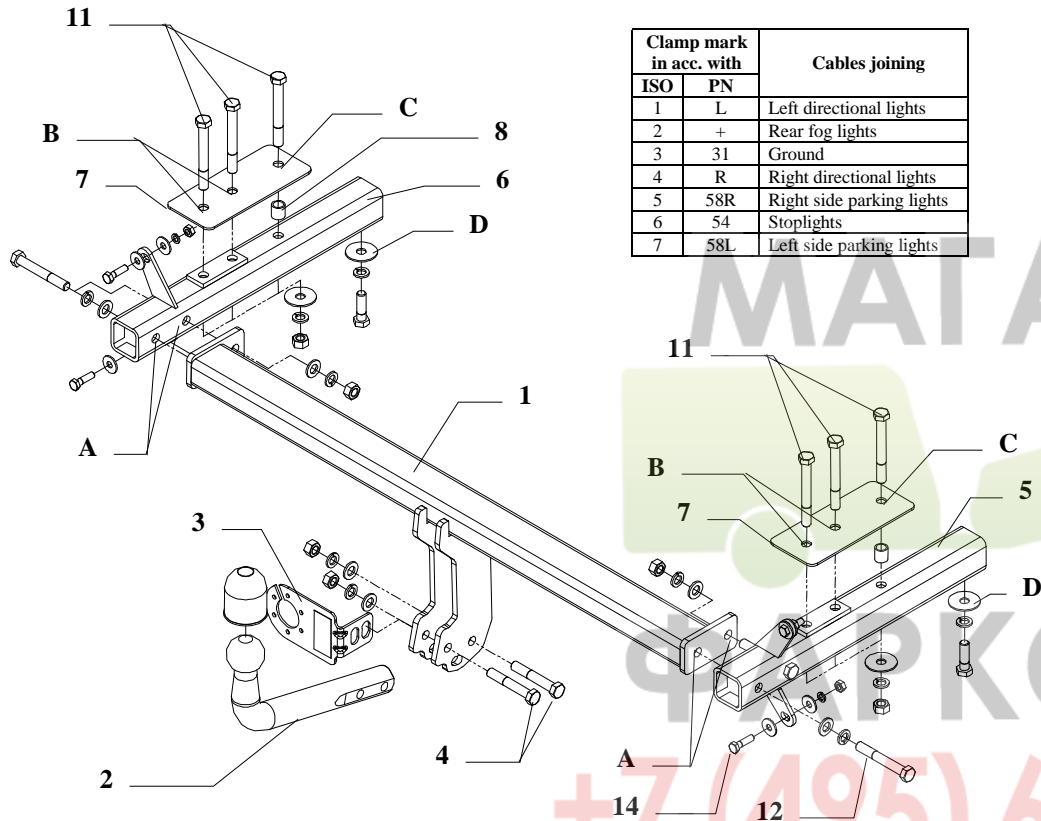

1. Lower the exhaust then remove the rear lights.
2. Remove the floor cover of the luggage trunk then loose the side plastic covers and fold them to the center of the trunk.
3. Remove the bumper and its inset then remove the bumper brackets (these will not be reinstalled later).
4. Enlarge the „C” factory holes on the floor plate of the trunk with a  $\varnothing 18\text{mm}$  drill.
5. Put the accessories pos. **5** and **6** into the chassis extension then according to the drawing loosely fix them at positions „B”, „C” and „D” with the attached bonding units (The accessory plates pos. **7** will be placed into the trunk, remember about distance sleeves pos. **8**!).
6. According to the drawing loosely fix the drag hook body (1) to the accessories **5** and **6** at positions „A” with bolts M12x85mm pos. **12**.
7. Using bolts M8x30 pos. **14** fix inset of the bumper.
8. Fix tow-ball (pos. **2**) and socket plate (pos. **3**) using bolts M12x75mm (pos. **4**) from accessories.
9. Tighten all bolts according to the torque shown in the table.
10. Reassemble bumper after cut out his fragment (80x35mm) in his bottom, central part. Next reassemble the rear lights.
11. Connect electric wires of 7-poles socket according to the instruction of the car. (Recommend to make at authorized service station)
12. Complete paint layer damaged during installation.

This towbar is designed to assembly in following cars:  
**KIA CARENS** produced since 09.2001 till 10.2006, catalogue no. **T43** and is prepared to tow trailers max total weight **1250 kg** and max vertical load **75 kg**.

Torque settings for nuts and bolts (8,8):

**M 8** 25 Nm  
**M 12** 85 Nm

**M 10** 55 Nm  
**M 14** 135Nm

### From manufacturer

Thank you for buying our product. Their reliability has been confirmed in many tests. Reliability of towbar depends also on correct assembly and right exploit. For this reasons we kindly ask to read carefully this instruction and apply to hints.

*The towbar should be install in points described by a car producer.*











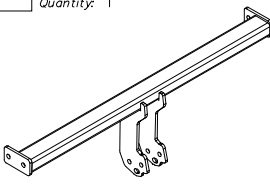
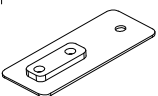

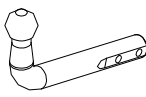
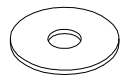

### NOTE

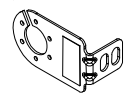
After install the towbar you should get adequate note in registration book (at authorised service station).The car should be equipped with:

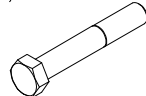
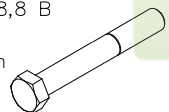
- Indicators
- Tow mirrors

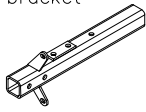
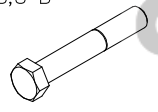
After 1000km check all bolts and nuts. The ball of towbar must be always kept clear and conserve with a grease.

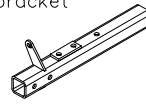
## Towbar accessories:

Pos. 1 Name: Main bar Quantity: 1 	Pos. 7 Name: Fish-plate Quantity: 2 	Pos. 14 Name: Bolt 8,8 B Quantity: 4 Dim.: M8x30mm 
	Pos. 8 Name: Distance sleeve Quantity: 2 Dim.: Ø17.2x2, L=18mm 	Pos. 15 Name: Nut 8 B Quantity: 10 Dim.: M12 
Pos. 2 Name: Tow ball Quantity: 1 	Pos. 9 Name: Washer Quantity: 8 Dim.: Ø41xØ12.5x2mm 	Pos. 16 Name: Nut 8 B Quantity: 4 Dim.: M8 
Pos. 3 Name: Socket plate Quantity: 1 	Pos. 10 Name: Washer Quantity: 8 Dim.: Ø24xØ9x2mm 	Pos. 17 Name: Plain washer Quantity: 6 Dim.: Ø 13 mm 
Pos. 4 Name: Bolt 8,8 B Quantity: 2 Dim.: M12x75mm 	Pos. 11 Name: Bolt 8,8 B Quantity: 6 Dim.: M12x100mm 	Pos. 18 Name: Spring washer Quantity: 14 Dim.: Ø 12,2 mm 
Pos. 5 Name: Right bracket Quantity: 1 	Pos. 12 Name: Bolt 8,8 B Quantity: 4 Dim.: M12x85mm 	Pos. 19 Name: Spring washer Quantity: 4 Dim.: Ø 8,2 mm 
Pos. 6 Name: Left bracket Quantity: 1 	Pos. 13 Name: Bolt 8,8 B Quantity: 2 Dim.: M12x40mm 	Pos. 20 Name: Ball cover Quantity: 1 



**PPUH AUTO-HAK S.J.**

Produkcja Haków Holowniczych  
Henryk & Zbigniew Nejman  
76-200 SŁUPSK ul. Słoneczna 16K  
tel/fax (059) 8-414-414; 8-414-413  
E-mail: [office@autohak.com.pl](mailto:office@autohak.com.pl)  
[www.autohak.com.pl](http://www.autohak.com.pl)

## Towing hitch (without electrical set)

Class: A50-X Cat. no. T43

Designed for:

Manufacturer: KIA

Model: CARENS

produced since 09.2001 till 10.2006

Technical data:

**D-value: 7,6 kN**

maximum trailer weight: **1250 kg**

maximum vertical cup load: **75 kg**

**Approval number acc. to regulations EKG/ONZ 55.01: E20-55R-01 1369**

## Foreword

This towbar is designed according to rules of safety traffic regulations. The towing hitch is a safety component and can be install only by qualified personnel. Any alteration or conversion of the towing hitch is prohibited and would lead to cancellation of design certification. Remove insulating compound and underseal from vehicle (if present) in the area of the matting surfaces of the towing hitch. The vehicle manufacturer's specifications regarding trailer load and max. vertical cup load are decisive for driving whereat values for the towing hitch cannot be exceeded.

*D-value formula:*

$$\frac{\text{Max trailer weight [kg]} \times \text{Max vehicle weight [kg]}}{\text{Max trailer weight [kg]} + \text{Max vehicle weight [kg]}} \times \frac{9,81}{1000} = D \text{ [kN]}$$